

elna
SWISS DESIGN

lotus

SEW EASY.

elna
SWISS DESIGN



ELNA LOTUS AT MoMA

A compact machine with a unique design: the original Elna Lotus from 1968 is in the collection of The Museum of Modern Art (MoMA) in New York.

The Lotus was Elna's best selling machine of all time and a worldwide success: over one million machines were sold.



THE LOTUS SPIRIT

Compact. Simple. Enjoyable.

The new Elna Lotus combines maximum sewing pleasure and minimum fuss. With sturdy flaps that help protect the machine and create a handy, generous sewing table, it is the ultimate all-in-one sewing machine.

From the integrated pop-up spool pin at the head of the machine to the automatic thread cutter, integrated needle threader and accessory storage, the compact and streamlined design aids practicality and portability. Our finishing touch was to place the needle bar in a unique position in the centre of the machine to give you much more room to move and manoeuvre your fabric.

Simplicity and ease-of-use: that's the Lotus spirit.

HAPPY SEWING!

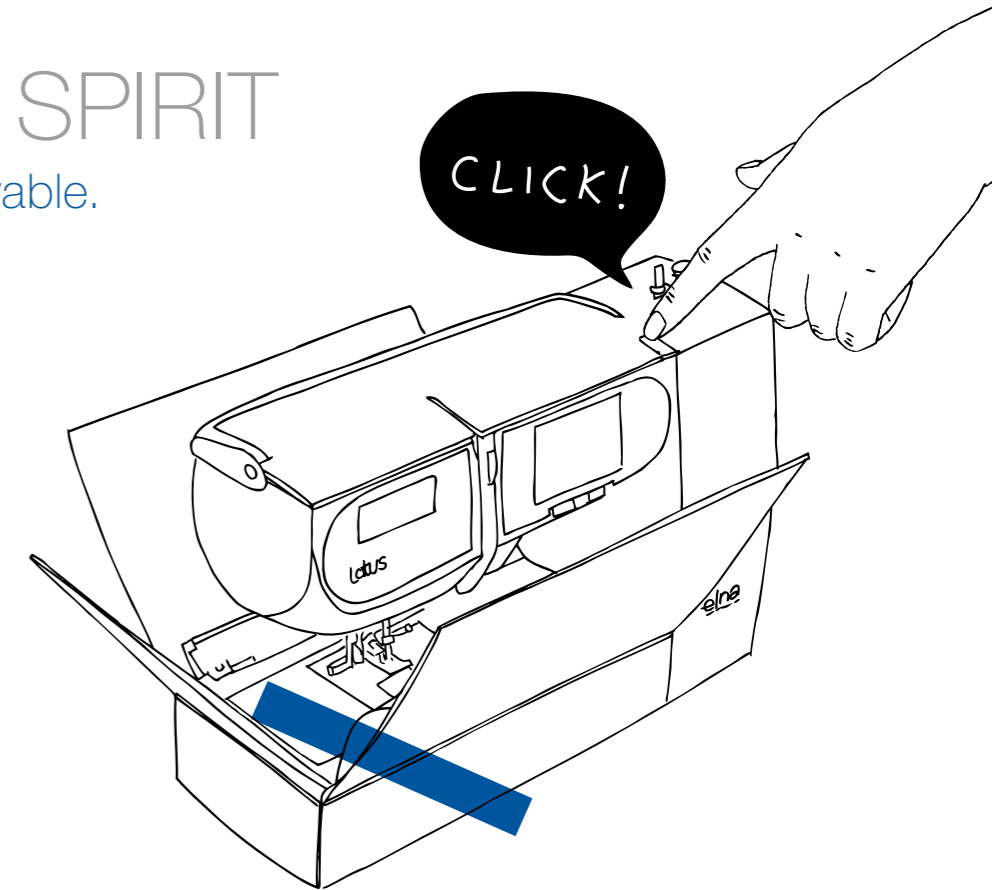



THE 'ALL-IN-ONE' SEWING MACHINE

READY, STEADY, SEW!

Sewing fans will love the fact that they can always have their Elna Lotus to hand. Thanks to its 'carry-case' concept and folding flaps that open with the flick of a lever, you'll always be ready to sew on the go.

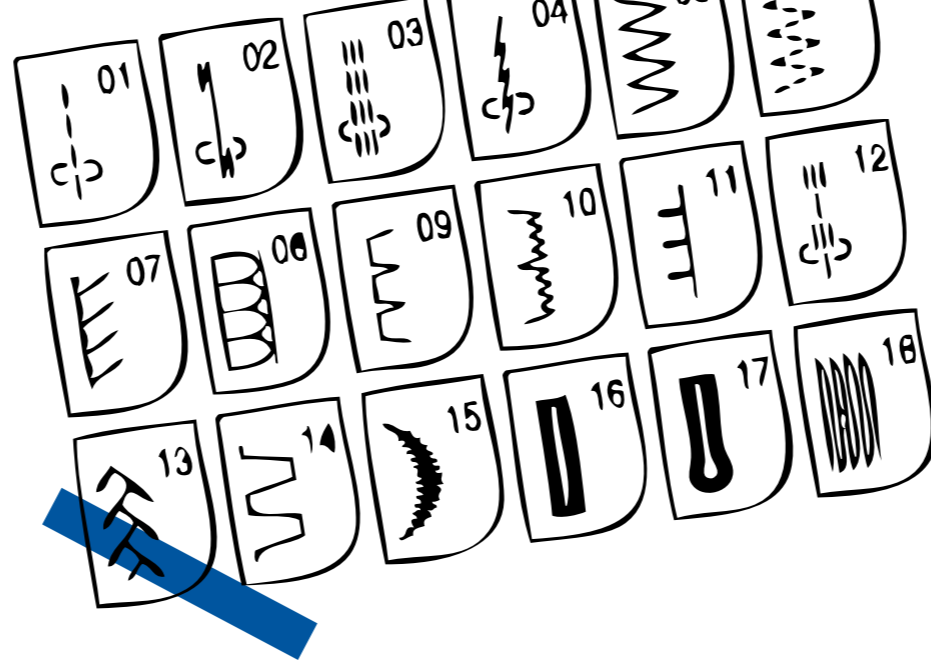

THE ESSENTIALS. NOTHING MORE, NOTHING LESS.

SIMPLER SEWING FOR THOSE
WHO SIMPLY LOVE TO SEW.

18 stitches selected for their sewing suitability. We've combined utility stitches with decorative stitches to create a range of effects, from patchwork, quilting, buttonholes and darning to appliqué and embellishments. Simply switch stitches at the touch of a button! Utility stitches include straight stitch, stretch, zigzag and super overlock. Decorative stitches encompass patchwork and bridging stitch and scallop edges. You'll also make use of the classic square and classic keyhole buttonholes as well as the darning stitch. You'll have the confidence to give your sewing a professional finish.

The Lotus comes with a comprehensive instruction manual, which provides a complete list of stitches, their uses and instructions.

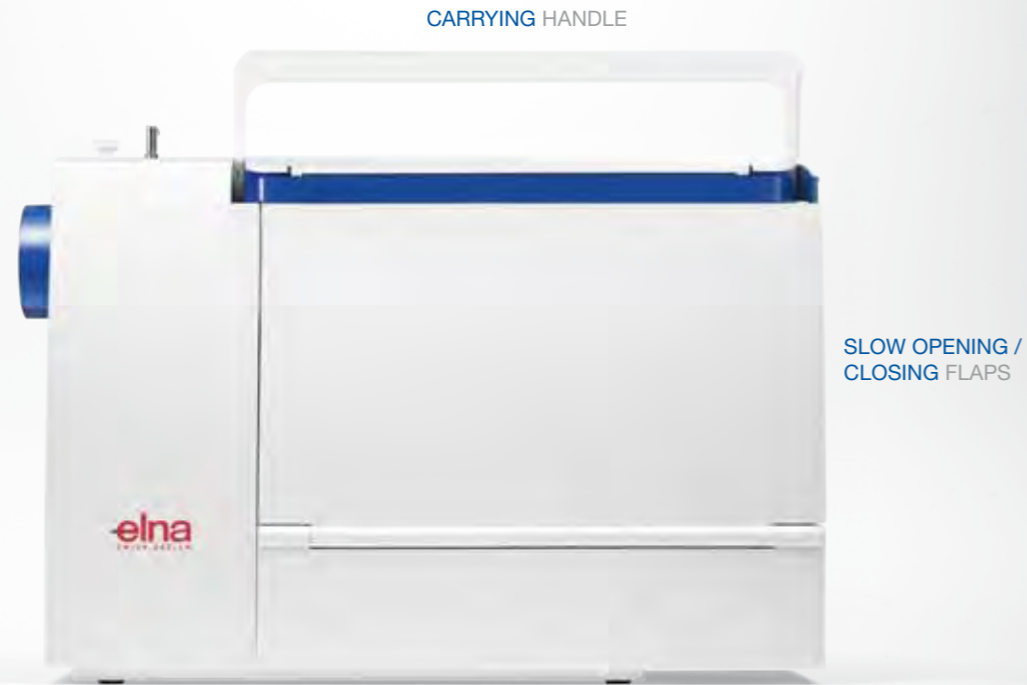

FLAPS OPENED = EXTRA-WIDE SEWING AREA

Comfortable, easy sewing with a host of professional features.

INTEGRATED BOBBIN SPOOL FOR PERMANENT THREADING

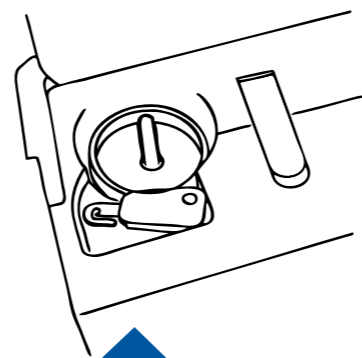
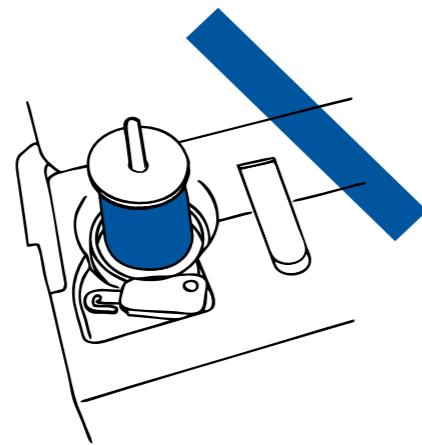
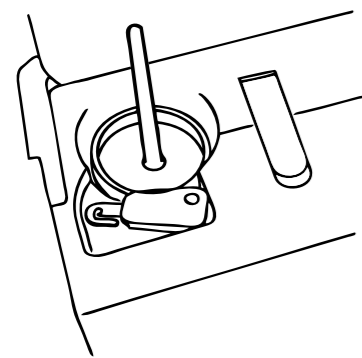
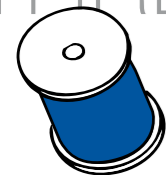

POPS UP... AND AWAY!

The bobbin spool pin springs up and pops back in, making it easy to change thread spools of any size. A spool neatly integrated into the machine contributes to the Lotus' sleek design and also ensures it cannot be damaged or snapped during transport.



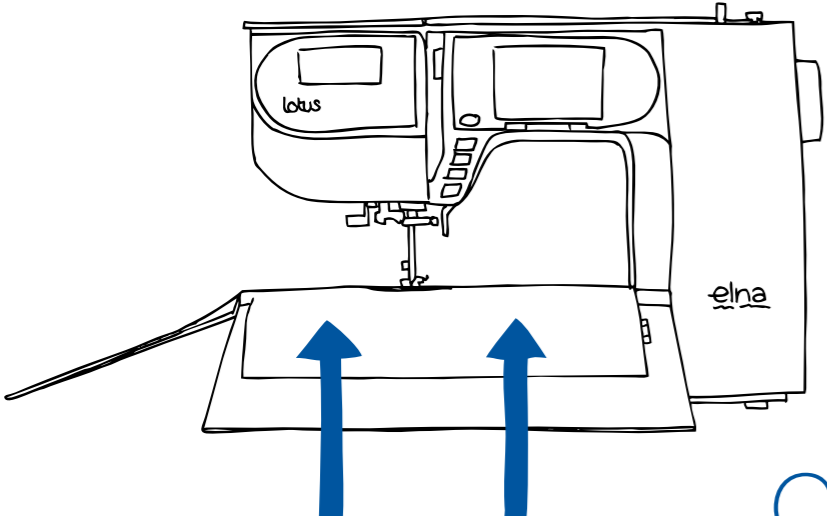

SIMPLE BUT BRILLIANT!

CENTRALISED NEEDLE BAR

MORE SPACE,
MORE STABILITY.

Whether it's a heavy pair of curtains, a bulky patchwork project or delicate, slippery material, the centralised needle bar gives you plenty of room to move and manoeuvre your fabric. Space to hold the cloth in place with both hands makes for stable sewing and slicker results.

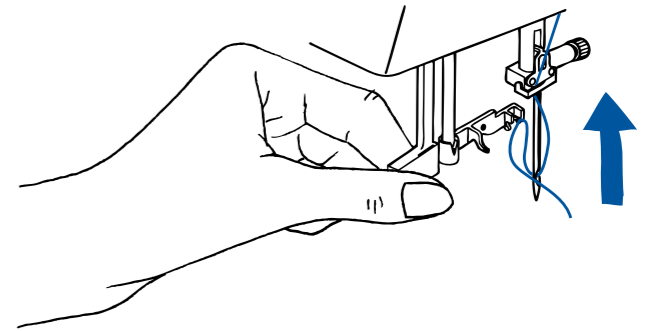
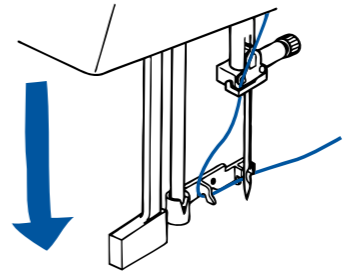
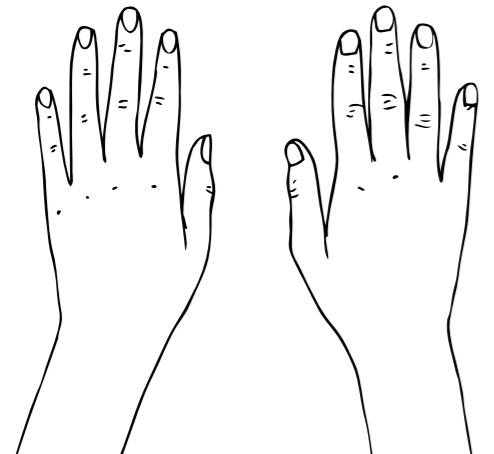

BUILT-IN AUTOMATIC NEEDLE THREADER

READY TO SEW IN AN INSTANT.

A handy needle threader puts an end to fiddly threading. You can get started with no fuss or quickly change threads as you sew.

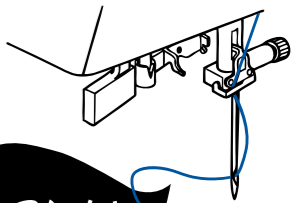

EASY!



PUSH BUTTONS:
THREAD CUTTER,
NEEDLE POSITION,
AUTOLOCK,
REVERSE,
START & STOP

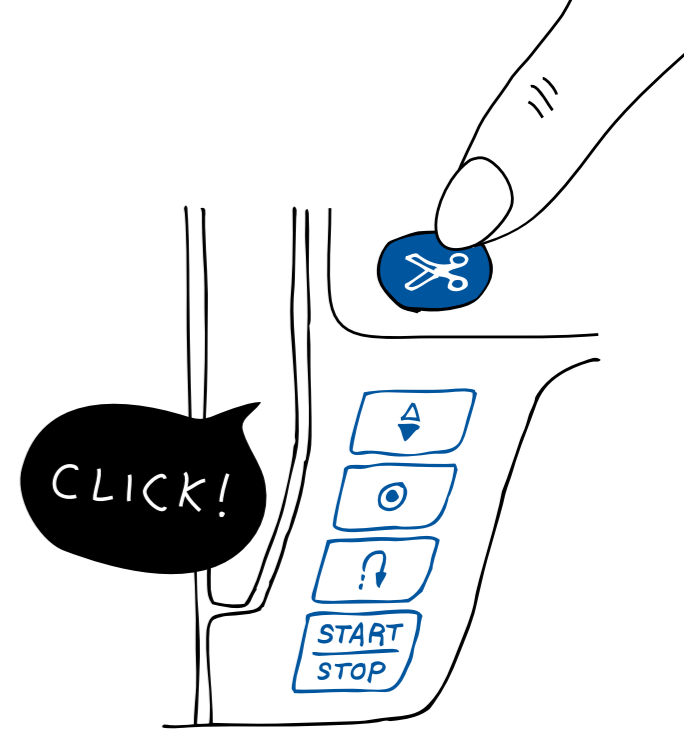

THE SCHOOL OF SWISS FINISHING.

Start and finish your sewing with seamless results. Five handy buttons bring perfection to your project. 'Start/Stop' gets you going without the foot pedal. 'Reverse Stitch' adds strength with some nifty backstitching. 'Autolock' creates an end knot after finishing the stitch design. The 'Up/Down needle position' allows you to halt the needle in the fabric or in the 'up' position, whilst the 'Thread Cutter' button swiftly snips away remaining thread for a flawless finish.

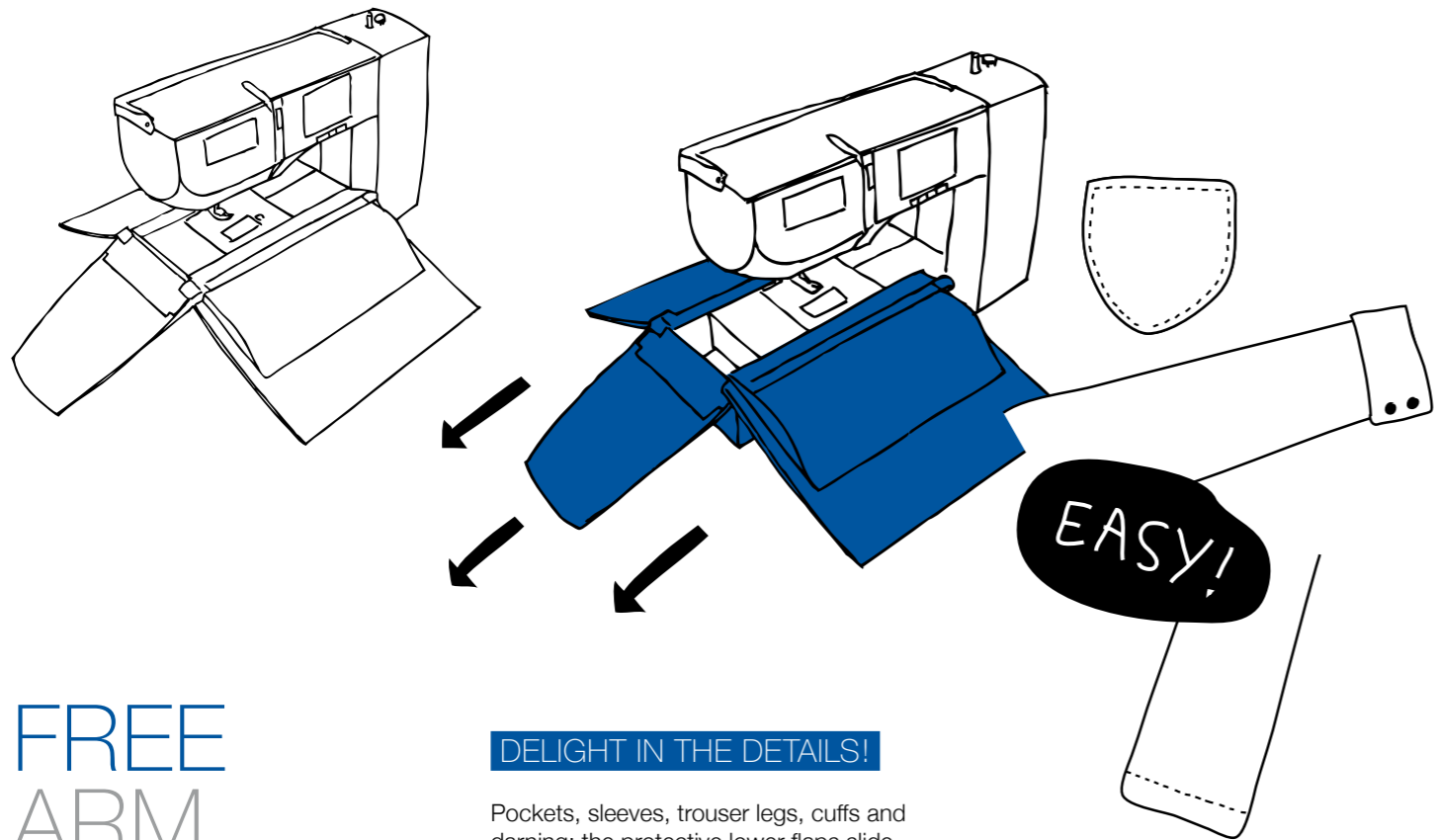

FREE ARM

DELIGHT IN THE DETAILS!

Pockets, sleeves, trouser legs, cuffs and darning: the protective lower flaps slide away to reveal the rounded, shaped free arm. The free arm is particularly useful when sewing tubular items, smaller projects and repairs. Tricky just got easy.





DUAL ACCESSORY STORAGE

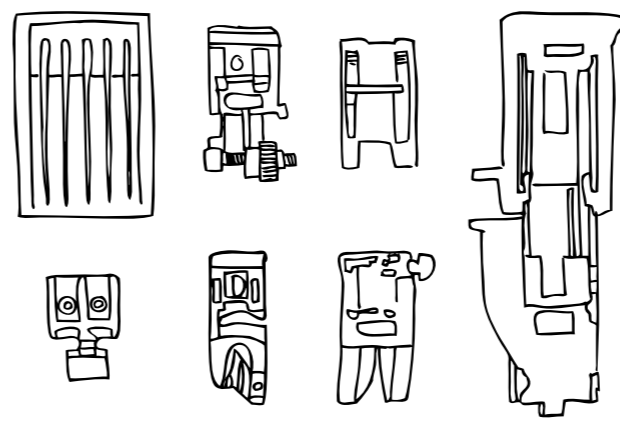
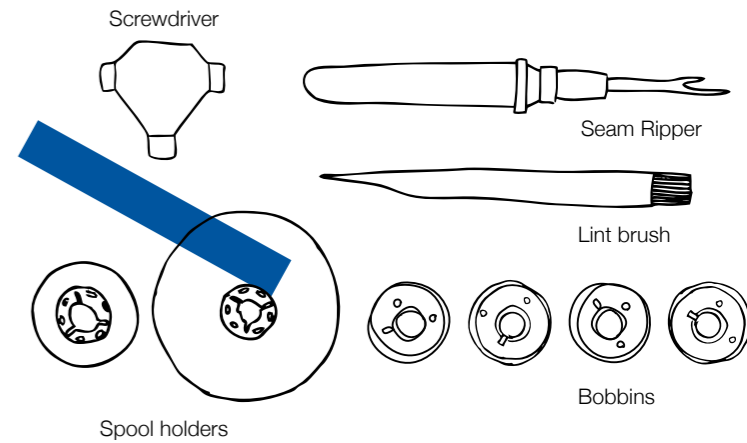

**A PRIME EXAMPLE
OF SWISS DESIGN.**

Everything in its place and a place for everything. Open the top cover flap and you will find a storage area for the machine essentials (needles, sewing feet, buttonhole foot, instruction chart, etc). Slide open the grip front flap to reveal the accessory drawer for items that are useful to have close at hand: bobbins, lint brush, spool holder, screwdriver and seam ripper.



TECHNICAL SHEET

FEATURES

Computerized model
 Horizontal rotary hook with transparent bobbin cover
 Free arm
 Body dimensions: W 426 mm / H 298 mm / D 155 mm
 Free arm dimensions: L 162.5 mm / H 110 mm
 Start with foot controller or Start/Stop key
 Speed control up to 700 stitches/min. with the Start/Stop key
 Speed control up to 820 stitches/min. with the foot controller
 Vertical spool pin with Pop-up system
 Automatic thread cutter
 Two accessory storage areas – top cover and drawer
 Integrated sewing table, made by the flaps
 LCD screen: W 62 mm / H 27 mm
 Two white LED lamps

ACCESSORIES

4 bobbins
 Assorted needle set
 Screwdriver
 Seam ripper
 Lint brush
 Spool holder (large)
 Spool holder (small)
 Zigzag foot A
 Zipper foot E
 Blind hem foot G
 Satin stitch foot F
 Rolled hem foot D
 Automatic buttonhole foot R
 Power supply cable
 Foot controller
 Instruction manual
 Foot control and power supply cable case

TECHNICAL FEATURES

18 stitches
 Two one-step buttonholes
 Maximum stitch width: 7 mm
 Maximum stitch length: 5 mm
 Direct stitch selection on the touch screen
 Automatic needle threader
 Start/Stop key
 Reverse stitch key
 Autolock key
 Needle Up/Down key
 Automatic thread cutter key
 Automatic bobbin-winding with automatic declutch system
 Manual thread tension control
 Extra-high pressure foot lift
 Drop feed dog
 Clip-on presser feet
 Metallic shuttle hook
 Thread cutter on the machine head
 Flaps release lever

STITCHES PANEL



